

Data Sheet



Article number: 604144024030

Description: Timing belt pulley with hub
HTD 24 8M 30

Measures

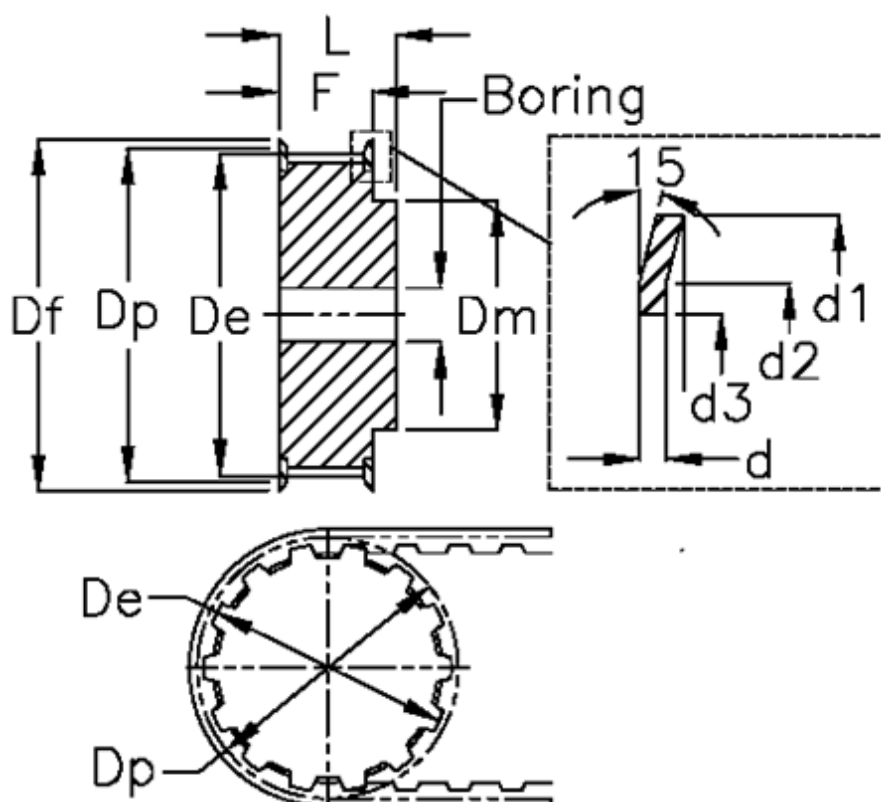

Bore = 12	Dp = 61.12
d = 1.5	F = 38
d1 = 66	Flange type = F25
d2 = 63	L = 48
d3 = 52	Tooth number = 24
De = 59.75	Type = 8M
Df = 66	Weight = 0.84
Dm = 45	Width = 30